

# ARCONE®

## USER INSTRUCTION MANUAL 90x110 Auto-Darkening Filters and Helmets



**1000FcF**



**1500V**



**2000V**



**2500V**



**4000V**



**4500V**



**5000VX**



**5130VX**



**5500VX**



**6000V14**



**7000VX**



**7500VX**



**iDF48**

ARCONE® is a Division of A.C.E. International Company  
85 Independence Drive, Taunton, MA 02780, USA

TEL: +1 (508) 884-9600 • TOLL FREE: +1 (800) 223-4685 • FAX: +1 (508) 884-9666

Please visit our website: [www.arc1weldsafe.com](http://www.arc1weldsafe.com)

# Table of Contents

Page

Preparations for Use.....	1
Technical Information / Use .....	1
Limitations of Use .....	3
Care and Maintenance .....	4
Spatter Protection.....	4
Information on Disposal.....	5
Parts Selection Guide.....	5-7
Filter Specifications .....	8-9
Significance of Markings.....	10
Shade Selection Guide .....	11
Filter Removal Diagram .....	11

## Preparations for Use

**WARNING, materials which may come in contact with the wearer’s skin may cause an allergic reaction to susceptible individuals.**

*Filters:*

Before you begin welding always inspect your filter to ensure it is not damaged. Check to see if the filter protection plates (cover plates) are clean, clear, undamaged, and securely attached to the helmet and covering the auto-darkening filter both front and rear. Make sure the filter will turn dark before using. Direct toward a bright light source or use a torch striker. Direct sunlight may not darken the filter.

**WARNING, never begin welding without first checking to see if the correct front and rear protection plates are in place (See Part Selection Guide section for part numbers). Failure to protect the welding filter may cause damage and become a safety hazard should the UV/IR protection be compromised from spatter or cracks from impact.**

**DAMAGE CAUSED BY ABUSE SUCH AS EXCESSIVE TEMPERATURES, CRACKS FROM IMPACT, AND PITTING FROM SPATTER CAUSED BY POOR MAINTENANCE WILL VOID WARRANTY.**

**Not for use in overhead welding.**

**WARNING, toughened mineral filter oculars shall only be used in conjunction with a suitable backing ocular.**

*Welding Helmets:*

Before you begin welding make sure there is no damage to the helmet shell including, but not limited to, cracks, holes, and melting. Ensure that the springs holding the filter are not broken or corroded. Do not use the helmet if any of these conditions exist and contact your distributor for replacement parts. Use only replacement components as specified for each welding helmet in accordance with this user manual.

Adjust headgear for comfort and proper sight-line through the filter (see Parts Selection Guide).

**WARNING, other safety precautions such as protective clothing, adequate ventilation, breathing protection (e.g. powered air purifying respirator), fire extinguisher, and protection for co-workers, should also be considered. Consult an Industrial Hygienist to ensure adequate protection is being provided.**

## Technical Information / Use

*Filters:*

**ArcOne®** auto-darkening filters protect the user against harmful ultra-violet and infrared UV/IR rays, both in the dark and light state. No matter what shade the filter is set to the UV/IR protection is provided. When used properly, the filter will prevent your eyes from being burned by optical radiation.

**WARNING, severe burns are possible with a damaged lens (cracks, pits, holes, etc.). Do not use damaged lens. Optical radiation can possibly enter in from behind the helmet from other welders welding in the immediate area.**

## Shade Adjustment (refer to Figures 1 through 4):

See Filter Specifications (Table 1) for filter specifications.

See CE Shade Selection Guide (Table 2) for recommended shades for arc welding applications.

**Digital LCD Controlled Variable Filters (see Figure 1):** Briefly press the “Mode” button (see Figure 1), the LCD mode will flash to indicate the current setting. Press and hold the “+” or “-” button to change the setting. The number will change on LCD.

**Analog Controlled Variable Filters (see Figure 2):**

**External Control:** Set filter to desired dark shade with the shade knob located on the outside of the helmet. The Shade Number will change on the LCD (see Figures 3 and 4) as the user turns the knob up or down. Some models have a single external knob for shade only.

**Internal Control:** Set filter to desired dark shade with the shade knob located on the filter.

The configuration of internal controls vary; however, each knob is labeled according to function, also, buttons are labeled or marked according to function.

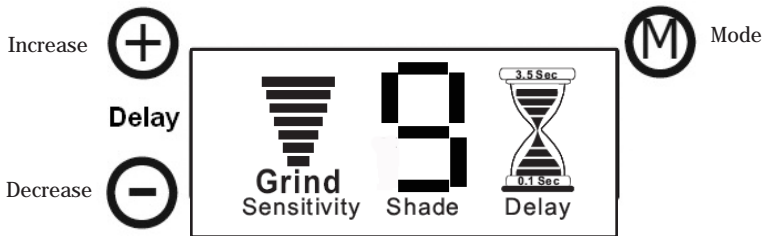

Figure 1: Digital Controls

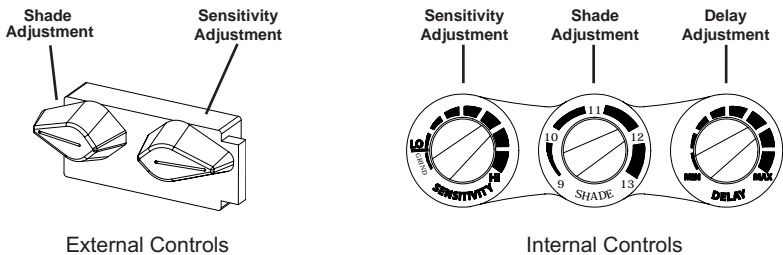

Figure 2: Analog Controls

## Sensitivity Adjustment

**Digitally Controlled Filters:** Briefly press the “Mode” button (see Figure 1), the LCD mode will flash to indicate the current setting (see Figure 3). Press and hold the “+” or “-” button to change the setting.

**Analog Controlled Filters:** Models with external or internal control turn the knob to change the sensitivity (see Figure 2), increasing or decreasing it. Some Digital LCD models will display the level of sensitivity (see Figure 1), where more bars equals increased sensitivity.

### X-TIG Mode:

Filters 5000VX, 5130VX, 5500VX, 7000VX, and 7500VX, have an X-TIG mode ideal for TIG welding applications. When set to X-TIG, the digital display will show “X-TIG” in the sensitivity column (see Figure 3b).

**5000VX and 7000VX:** X-TIG is accessed via an external switch on the outside control. Turn until the control knob clicks into place and the LCD displays “X-TIG.”

**5130VX, 5500VX, and 7500VX:** Use the “+” button to set the sensitivity to the highest setting.

### I-TIG Mode:

The iDF48 (USA) has iTIG mode. See the following page for more details.



**Figure 3a: LCD Readout**  
(5000V, 5500V, 5130V, 7000V,  
and 7500V)

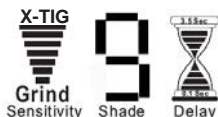

**Figure 3b: LCD Readout**  
(5000VX, 5500VX, 5130VX,  
7000VX, and 7500VX)



**Figure 3c: LCD Readout**  
(iDF48)

## Delay Adjustment and Grind Mode (not on all Models)

**Digital Controlled Filters:** Briefly press the “Mode” button (see Figure 1), the LCD mode will flash to indicate the current setting (see Figure 3). Press and hold the “+” or “-” button to change the setting. **NOTE:** Some models have a dedicated Delay button with the “+” or “-” to change the setting.

**Analog Controlled Filters:** Feature is not available on all analog models. Refer to Table 1: Filter Specifications.

**1000FCF:** Turn Sensitivity knob counter-clockwise past the white line to lock into Grind Mode.

**4000V:** Turn Shade knob counter-clockwise past shade 9 to enter Grind Mode.

**4500V:** Set switch located on back of filter in the down position labeled “GRIND.” Set to “WELD” before any welding application.

**6000VI4:** Press the “Delay” button on the back of the control center to turn delay on or off.

## Intelligent Darkening Filter (IDF) Modes

The iDF48 in the USA has both Auto-Variable and iTIG Mode; models outside the USA have only Auto-Variable Mode. To switch from one mode to another Press AND Hold down the “Mode” button for two seconds. To cycle through modes continue depressing the “Mode” button. (\*\*NOTE: Modes will not switch when in Grind Mode.)

**Auto-Variable Mode:** LCD displays “AUTO” (see Figure 3c). Press, but do not hold, the “Mode” button to select between shades 5-8 or shades 9-13. Filter automatically responds to the intensity of the welding arc and sets the filter to the appropriate dark shade. The Auto-Variable mode is dependent upon light intensity of the arc and distance from the filter to the arc. The user can further adjust the dark shade up or down one shade number for comfort while the word “AUTO” is flashing. This mode has one memory position for each shade in the dark state; i.e. 9, 10, 11, 12, and 13. (**NOTE:** Shade 13 cannot be set higher than 13. This Mode only works on split range; i.e. 5-8/9-13 filters in the higher shade range). To reset all memory slots press and hold both “Mode” and “Delay” buttons for two (2) seconds.

**iTIG Mode:** Upon entering iTIG mode, where LCD displays “TIG” icon and flashing “(•)” (see Figure 4) user first sets lower desired shade while the “(•)” flashes. After approximately five (5) seconds of not turning the shade knob the flashing stops and the user can then set the desired upper shade. The lowest possible shade is fixed according to the standard to which the filter has been tested (example: iDF48, iTIG in 9-13 range shade 9 lowest and shade 13 highest, in 5-9 range shade 7 lowest and shade 9 highest.)

## Limitations of Use

### Filters:

**ArcOne®** welding filters are not designed for oxy-acetylene, laser, or very low amperage welding applications. Arc detection may be impaired due to amperage, distance from the arc, welding current frequency, electrode type, shielding gasses, and lighting conditions.

**DO NOT** weld with filter in the light state. If the filter fails to turn dark immediately stop use and contact a service provider for help.

### Welding Helmets:

Welding helmets are designed to provide protection against UV/IR radiation around the user's face. **ArcOne®** welding helmets meet/exceed face coverage defined by CE standards. **ArcOne®** welding helmets are suitable for arc welding. Refer to any or all of the following standards for more specifications: ANSI Z87, CAN/CSA Z94.3, and CE EN 166 & 175.

**CAUTION:** not meant to protect against Severe Impact, explosives, fragments from grinding wheels, abrasive discs, and hazardous fluids. Use secondary impact protection, such as safety glasses.

## Limitations of Use Continued

**DO NOT** use this helmet without proper training from a certified welder or welding instructor.  
**DO NOT** use this helmet in an excessive heat environment where the operation of the filter becomes non-functional due to exceeding the temperature ratings of the electronic components.

## Care and Maintenance

**NOTE: Replacement components must be used in accordance with these instructions. Failure to use ArcOne® replacement components in accordance with these instructions voids certification of this product.**

### *Filters:*

Filters require virtually no maintenance other than periodic cleaning when the lens, solar panel, and/or sensor(s) become dirty or clouded from smoke. Dampen a soft cloth or paper towel with window cleaner or a mild soapy solution and gently wipe clean (do not immerse in water or solution). Change the cover plates frequently. Storage Temperature -10 - 38°C (14 - 100°F)

Models with a replaceable battery will need the battery changed periodically when the Low Battery LED/LCD indicates.

### *Welding Helmets:*

Welding helmets require virtually no maintenance other than periodic cleaning when dirty. Clean your helmet by using a mild soapy solution and a soft cloth or paper towel (do not immerse in water or solution).

**DO NOT** throw or abuse the helmet. Doing so may crack the helmet shell and compromise the protection.

### *Protection (Cover) Plates:*

Change cover plates when they lose flexibility and/or become bowed or distorted. Clean with mild soapy solution including any build-up from the area where the cover plate is retained.

Discard if cleaning fails to improve visibility or cracks, scratches, etc. impair visibility.

### *Storage:*

Equipment may be stored in original packaging or similar packaging. Store in a safe and dry location away from direct heat.

## Spatter Protection

### ***SPATTER DAMAGE IS NOT COVERED BY WARRANTY***

Ensure that the helmet is always equipped with an Outside Cover Plate (in front of the filter, on the outside of the helmet) and an Inside Cover Plate (behind the filter, on the inside of the helmet). These cover plates must be replaced if broken, warped, damaged, or covered with welding spatter such that vision is impaired. Replace regularly only with **ArcOne®** cover plates.

***All helmets use 1 mm thick cover plates.***

# Information on Disposal for Users of Waste Electrical & Electronic Equipment (WEEE)

## For private household users in the European Union

The WEEE symbol on the product(s) and / or accompanying documents (see Figure 4) means that used electrical and electronic products should not be mixed with general household waste. For proper treatment, recovery and recycling, please take this product(s) to designated collection points where it will be accepted free of charge. Alternatively, in some countries you may be able to return your products to your local retailer upon purchase of an equivalent new product.

Disposing of this product correctly will help save valuable resources and prevent any potential negative effects on human health and the environment, which could otherwise arise from inappropriate waste handling.



Figure 4: WEEE Symbol

Please contact your local authority for further details of your nearest designated collection point. Penalties may be applicable for incorrect disposal of this waste, in accordance with national legislation.

## For business users in the European Union

Please contact your dealer or supplier for information on the proper methods to discard your electrical and electronic equipment.

## Information on Disposal in other Countries outside the European Union

This symbol is only valid in the European Union. Please contact your local authorities or dealer and ask for the correct method of disposal.

# Parts Selection Guide

## Headgear

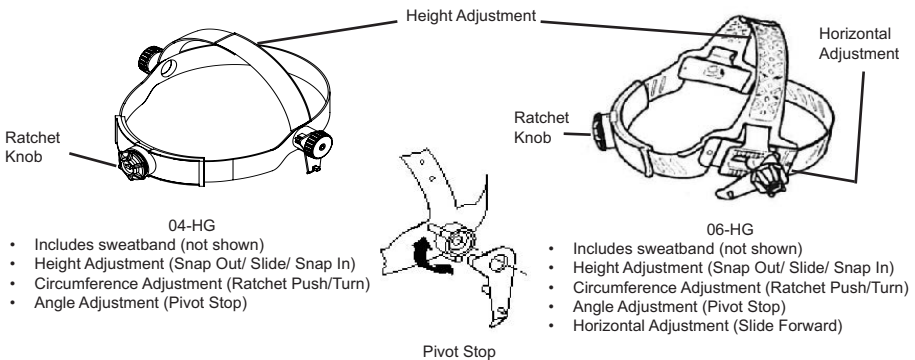

# CARRERA™ ArcOne®

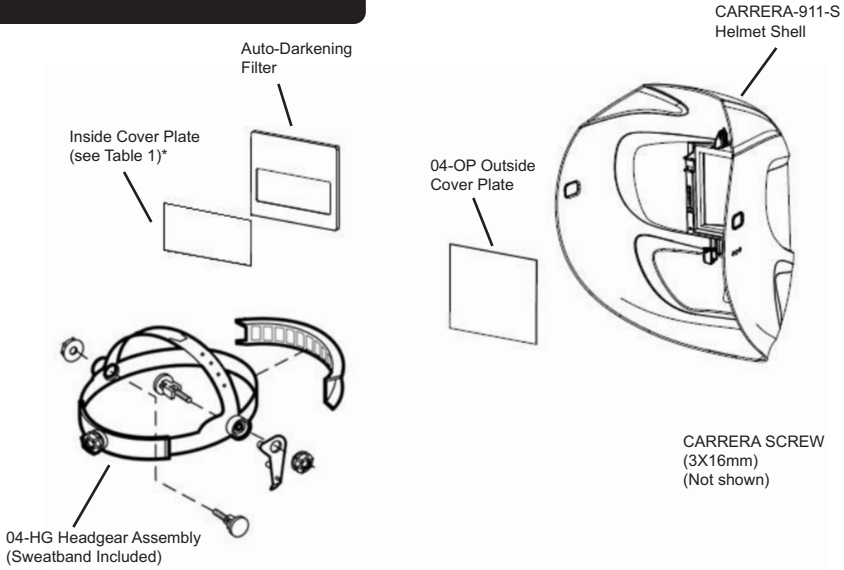

\*Optional Mag Lens, VML-XXX, Where XXX=Diopter number (Not shown)

# VISION®

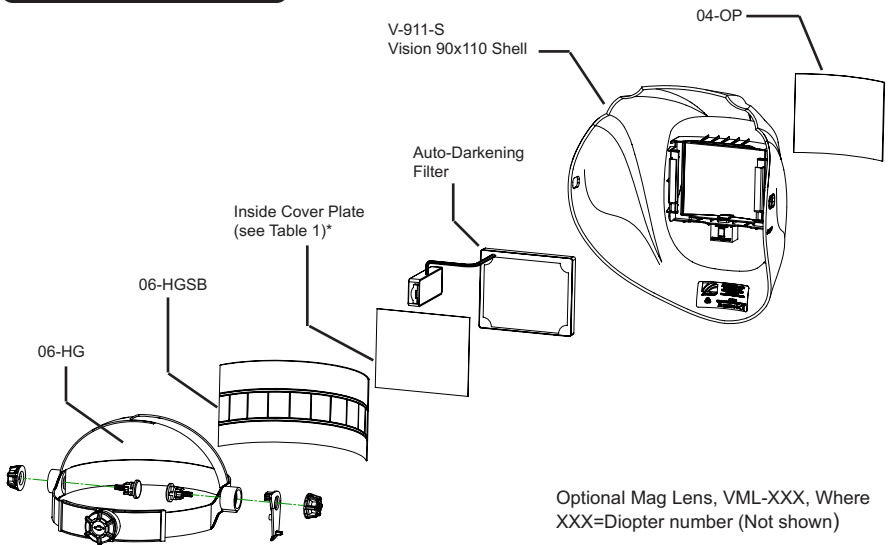

**PYTHON®**

\*Optional Mag Lens,  
VML-XXX, Where  
XXX=Diopter number  
(Not shown)

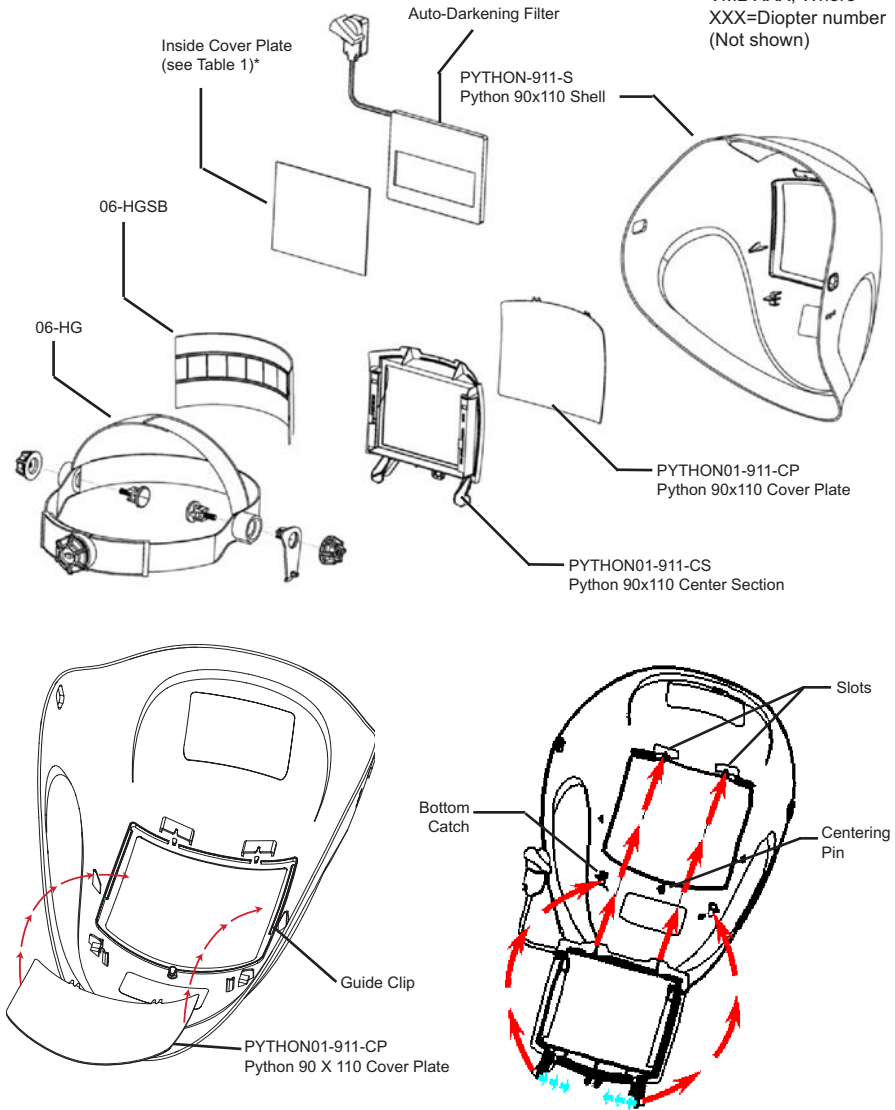

### Cover Plate Instructions:

With notches facing up, slide one side of cover plate into guide clip. Align notches and push other side of cover plate into guide clip. Cover plate will click into place.

### Center Section Instructions:

Slide A-D filter and inside cover plate into Filter Holder. Slide notches on top of Filter Holder into slots on helmet. Line up Filter Holder with Centering Pin on helmet, squeeze tabs on Filter Holder and push into tab slots. Release tabs into bottom catches.



## Table 1. Filter Specifications

	1000FcF	1500V	2000V	2500V	4000V	4500V	iDF48
Viewing Area	3864 mm <sup>2</sup> (6.0 sq in)	3864 mm <sup>2</sup> (6.0 sq in)	4704 mm <sup>2</sup> (7.3 sq in)	4704 mm <sup>2</sup> (7.3 sq in)	4500 mm <sup>2</sup> (7.0 sq in)	4500 mm <sup>2</sup> (7.0 sq in)	4608 mm <sup>2</sup> (7.1 sq in)
Filter Size	90x110 mm	90x110 mm	90x110 mm	90x110 mm	90x110 mm	90x110 mm	90x110 mm
ARC Sensing	Two sensors	Two sensors	Two sensors	Two sensors	Four sensors	Four sensors	Two Sensors
Sensitivity Control	Analog: Variable	Analog: Variable	Analog: Variable	Analog: Variable	Analog: Variable	Digital: Variable	Digital: Variable
Switching Time (seconds)	1/10,000 (0.1 msec)	5/10,000 (0.5 msec)	5/10,000 (0.5 msec)	1/10,000 (0.1 msec)	1/10,000 (0.1 msec)	1/10,000 (0.1 msec)	1/10,000 (0.1 msec)
Primary Power	Solar Cells	Solar Cells	Solar Cells	Solar Cells	Lithium Battery & Solar Cells	Lithium Battery & Solar Cells	AA Battery & Solar Cells
Back-up Power	Lithium Battery	Lithium Battery	Lithium Battery	Lithium Battery	Lithium Battery	Lithium Battery	Lithium Battery
Operating Temp.	-10-55C (14-131F)	-10-55C (14-131F)	-10-55C (14-131F)	-10-55C (14-131F)	-10-55C (14-131F)	-10-55C (14-131F)	-10-55C (14-131F)
Storage Temp.	-10-38C (14-100F)	-10-38C (14-100F)	-10-38C (14-100F)	-10-38C (14-100F)	-10-38C (14-100F)	-10-38C (14-100F)	-10-38C (14-100F)
UV / IR Protection	Up to Shade 16	Up to Shade 16	Up to Shade 16	Up to Shade 16	Up to Shade 16	Up to Shade 16	Up to Shade 16
Dark to Light Delay	0.2- 2 seconds	0.2-2 seconds	0.2-2 seconds	0.2-2 seconds	0.1-2 seconds	0.1-2 seconds	0.1-3.5 seconds
Light Shade	4	4	4	4	4	4	4
Dark Shade	9-13	9-13	9-13	9-13	9-13	9-13	5-8/9-13
Grind Mode	Yes	No	No	No	Yes	Yes	Yes
Intelligent Auto-Shade Mode	No	No	No	No	No	No	Yes
Intelligent TIG Mode	No	No	No	No	No	No	Yes
Enclosure Integrity	Not Dust/Water Resistant	Not Dust/Water Resistant	Not Dust/Water Resistant	Not Dust/Water Resistant	Not Dust/Water Resistant	Not Dust/Water Resistant	Dust/Water Resistant
Standards	<sup>4</sup> CE EN379	<sup>4</sup> CE EN379	<sup>4</sup> CE EN379	<sup>4</sup> CE EN379	<sup>4</sup> CE EN379	<sup>2</sup> CE EN379	<sup>3</sup> CE EN379
Optical Class	1	1	1	1	1	1	1
Diffusion of Light Class	2	2	2	2	1	1	1
Variation in Luminous Transmittance Class	1	1	1	1	1	1	1
Angle Dependency Class	3	3	3	3	2	2	2
Inside Cover Plate Part Numbers	03-OP	09-IP	03-OP	03-OP	03-OP	03-OP	04-OP

**Table 1. Filter Specifications (cont.)**

	<b>5000V &amp; 5000VX*</b>	<b>5130V &amp; 5130VX*</b>	<b>5500V &amp; 5500VX*</b>	<b>6000V14</b>	<b>7000V &amp; 7000VX*</b>	<b>7500V &amp; 7500VX*</b>
Viewing Area	4608 mm <sup>2</sup> (7.1 sq in)	4608 mm <sup>2</sup> (7.1 sq in)	4608 mm <sup>2</sup> (7.1 sq in)	8100 mm <sup>2</sup> (12.5 sq in)	5684 mm <sup>2</sup> (8.8 sq in)	5684 mm <sup>2</sup> (8.8 sq in)
Filter Size	90x110 mm	90x110 mm	90x110 mm	90x110 mm	90x110 mm	90x110 mm
ARC Sensing	Two sensors	Two sensors	Two sensors	Four Sensors	Two sensors	Two sensors
Sensitivity Control	Digital: Variable	Digital: Variable	Digital: Variable	Analog: Variable	Digital: Variable	Digital: Variable
Switching Time (seconds)	1/10,000 (0.1 msec)	1/10,000 (0.1 msec)	1/10,000 (0.1 msec)	1/10,000 (0.1 msec)	1/10,000 (0.1 msec)	1/10,000 (0.1 msec)
Primary Power	Solar Cells	Solar Cells	Solar Cells	Lithium Battery	Solar Cells	Solar Cells
Back-up Power	Lithium Battery	Lithium Battery	Lithium Battery	None	Lithium Battery	Lithium Battery
Operating Temp.	-10-55C (14-131F)	-10-55C (14-131F)	-10-55C (14-131F)	-10-55C (14-131F)	-5-55C (23-131F)	-5-55C (23-131F)
Storage Temp.	-10-38C (14-100F)	-10-38C (14-100F)	-10-38C (14-100F)	-10-38C (14-100F)	-10-38C (14-100F)	-10-38C (14-100F)
UV / IR Protection	Up to Shade 16	Up to Shade 16	Up to Shade 16	Up to Shade 16	Up to Shade 16	Up to Shade 16
Dark to Light Delay	0.1-3.5 seconds	0.1-3.5 seconds	0.1-3.5 seconds	0.1 or 2 seconds	0.1-3.5 seconds	0.1-3.5 seconds
Light Shade	4	4	4	4	4	4
Dark Shade	9-13	5-9/9-13	9-13	9-13	5-9/9-13	5-9/9-13
Grind "Mode"	Yes	Yes	Yes	Yes	Yes	Yes
Intelligent Auto-Shade "Mode"	No	No	No	No	No	No
Intelligent TIG "Mode"	No	No	No	No	No	No
Enclosure Integrity	Dust / Water Resistant	Dust / Water Resistant	Dust / Water Resistant	Dust / Water Resistant	Dust / Water Resistant	Dust / Water Resistant
Standards	<sup>2</sup> CE EN379	<sup>4</sup> CE EN379	<sup>2</sup> CE EN379	<sup>1</sup> CE EN379	<sup>4</sup> CE EN379	<sup>4</sup> CE EN379
Optical Class	1	1	1	1	1	1
Diffusion of Light Class	1	1	1	2	1	1
Variation in Luminous Transmittance Class	1	1	1	1	1	1
Angle Dependency Class	2	2	2	1	1	1
Inside Cover Plate Part Numbers	04-OP	04-OP	04-OP	04-OP	10-IP	10-IP

\*Filter variants designated with (X) have X-TIG "Mode" at the highest sensitivity setting. See Sensitivity Adjustment section for details.

## Significance of Markings:

### Welding Filters:

Examples: 4 / 5-8/9<13 AR M 1/1/1/2 EN379

4/ 5-9/9-13 AR 1/1/1/2 EN379

4 – Light Shade number

5-8 or 5-9 – Dark Shade range 1

9<13 – Dark Shade range 2 (Auto-Variable “Mode”)

9-13 – Dark Shade range 2 (Manual-Variable “Mode”)

AR – Manufacturers mark

M – Auto Variable

1 – Optical Class

1 – Diffusion of Light Class

1 – Variation in Luminous Transmittance class

2 – Angle Dependency class (This is a new classification of EN379. This marking may not be indicated on older models.)

### Welding Helmets:

Significance of CE Markings:

Example: AR EN 175 -F CE

AR – Company Identification Mark

EN 175 – CE Welding Helmet Standard

-F – Impact Class (Low Energy)

CE – European Mark

### Significance of Other Markings:

Example: AR Z87

AR – Company Identification Mark

Z87 – ANSI Standard for Eye and Face Protectors

Example: CAN/CSA Z94.3 **COLTS**® Labs

CAN/CSA Z94.3 – CSA Standard for Eye and Face Protectors

**COLTS**® Labs – CAN/CSA Certified Lab

### Product Certification Bodies

<sup>1</sup>This “Model” has been certified by:

Certottica SCARL

Zona Industriale Villanova

32013 Longarone (BL), Italy

Notified Body Number: 0530

<sup>2</sup>This “Model” has been certified by:

ECS GmbH

Obere BahnstraBe 25

73431 Aelen - Germany

Notified Body Number: 1883

<sup>3</sup>This “Model” has been certified by:

INSPEC International

56 Leslie Hough Way

Salford

Greater Manchester

M6 6AJ, England

Notified Body Number: 0194

<sup>4</sup>This “Model” has been certified by:

DIN CERTCO

Alboinstrasse 56

12103 Berlin, Germany

Notified Body Number: 0196

\*indicates pending certification

**Table 2: Shade Selection Guide**  
CE Shade selection Guide

Process	Current (Amps)																													
	1.5	6	10	15	30	40	60	70	100	125	150	175	200	225	250	300	350	400	450	500	600									
Covered Electrodes	8								9	10	11	12	13				14													
MAG	8								9	10	11	12	13				14													
TIG	8			9			10			11			12			13														
MIG with heavy metals	9								10	11			12			13			14											
MIG with light metals	10								11			12			13			14												
Air-arc gouging	10								11			12			13			14			15									
Plasma jet cutting	9								10	11			12			13														
Micro-plasma arc welding	4	5	6	7	8	9	10	11	12	1.5	6	10	15	30	40	60	70	100	125	150	175	200	225	250	300	350	400	450	500	600
NOTE: The term "heavy metals" applies to steels, alloy steels, copper and its alloys, etc.																														
***From CE EN 169:2002																														

### Filter Removal Diagram

